



www.nevpa.com.tr

Refrigerated Box, Dry Box Body Equipments

Frigo ve Kuru Yük Kutu Ekipmanları



1 External Lock Set



2 Hinge



4 PVC Profile

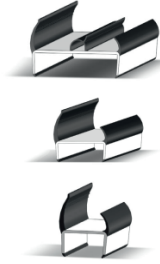

6 Rear Door Retainer



3 Side Door Hinge



5 Buffer



7 Recessed Door With Key



8 Lock



Curtainsider Equipments

Perdeli Üst Yapı Ekipmanları



1 Aluminium Rear Door With Accessories



2 Aluminium Side Door With Full Accessories

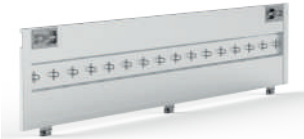

3 Side Structure Aluminium Profile

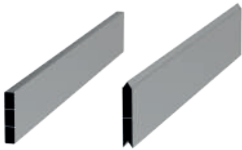

4 Dropside Pillar



5 Sliding Pillar

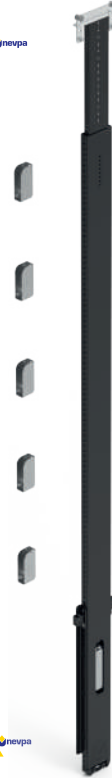

6 Sliding Pillar



8 Side Guard Complete Kit

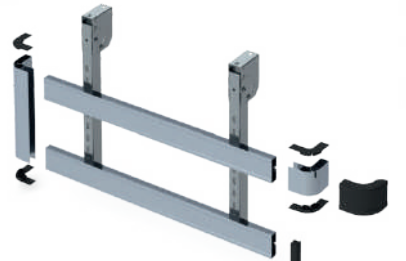

9 Sliding Roof System



10 Aluminium and Steel Rails



7 Rear Ladder



Open Box Equipments

Açık Kasa Üst Yapı Ekipmanları

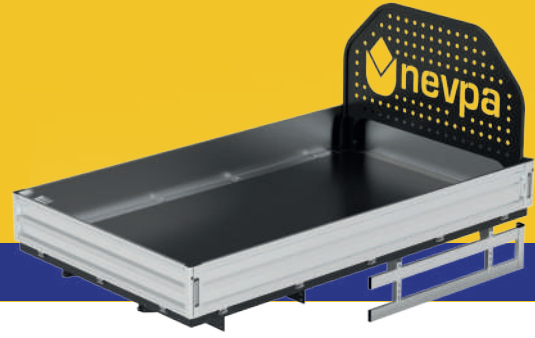

1 Vertical lock rear pillar
Right - Left



4 Steel Side Board



8 Complete Front Panel
(Steel - Aluminium)



2 Pillar



5 Aluminium Side Door
With Full Accessories

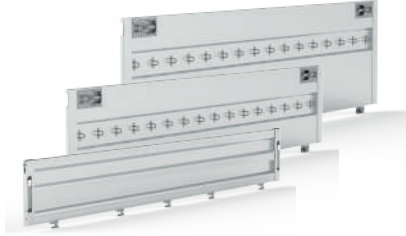

3 Pillar



6 Adjustable Safety
Bolt Fastener



6 Long Range Built
In Fastener



9 Soare Wheel Carriage



10 Mudguard's Pipe

10 Mudguard's Clamp



Quick Curtain System

Hızlı Perde Sistemleri



1 Double Handle Lock



2 Single Handle Lock



3 Handle



4 Curtain Upper Roller



5 Curtain Lower Roller



6 Aluminium Rail

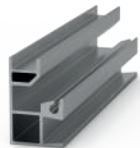

7 Head Profile



8 Tarpaulin





Aluminium Door Sets

Alüminyum Kapi, Kapak Setleri

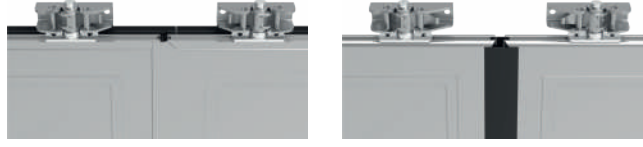

Aluminium Profiles

Alüminyum Profiller

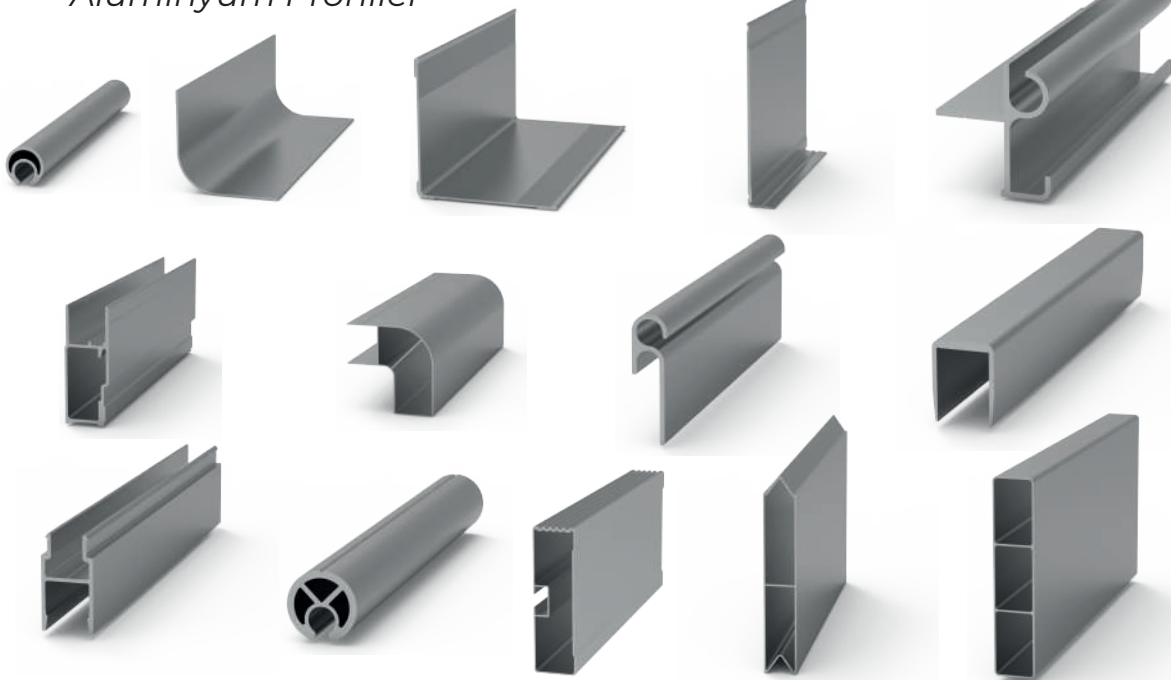



Our Distributorship

Çözüm Ortaklarımız

SESAM



HEYtex



KNORR-BREMSE



Riga Wood Latvijas Finieris Group

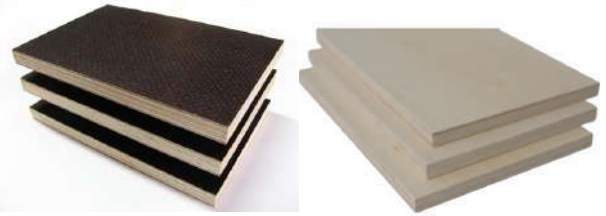

EMCO WHEATON

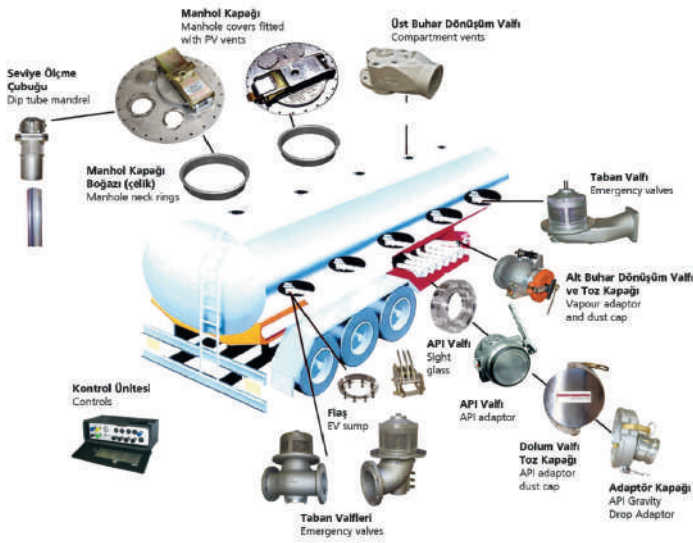

AVERY DENNISON

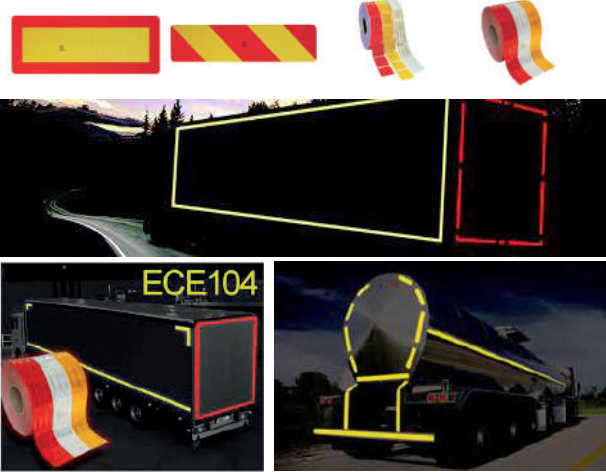

TIR

LONG VEHICLE

TIR

MEI





NEVPA TURKIYE



NEVPA UK



NEVPA EUROPE GERMANY



NEVPA INTERNATIONAL LLC UAE

**NEVPA IS LOCATED IN 4 DIFFERENT COUNTRIES AND
EXPORTS ITS PRODUCTS TO 57 DIFFERENT COUNTRIES**

www.nevpa.com.tr